

INSTRUCTION MANUAL

QUADBLASTER QB-4

ULTRASONIC BIRD REPELLER

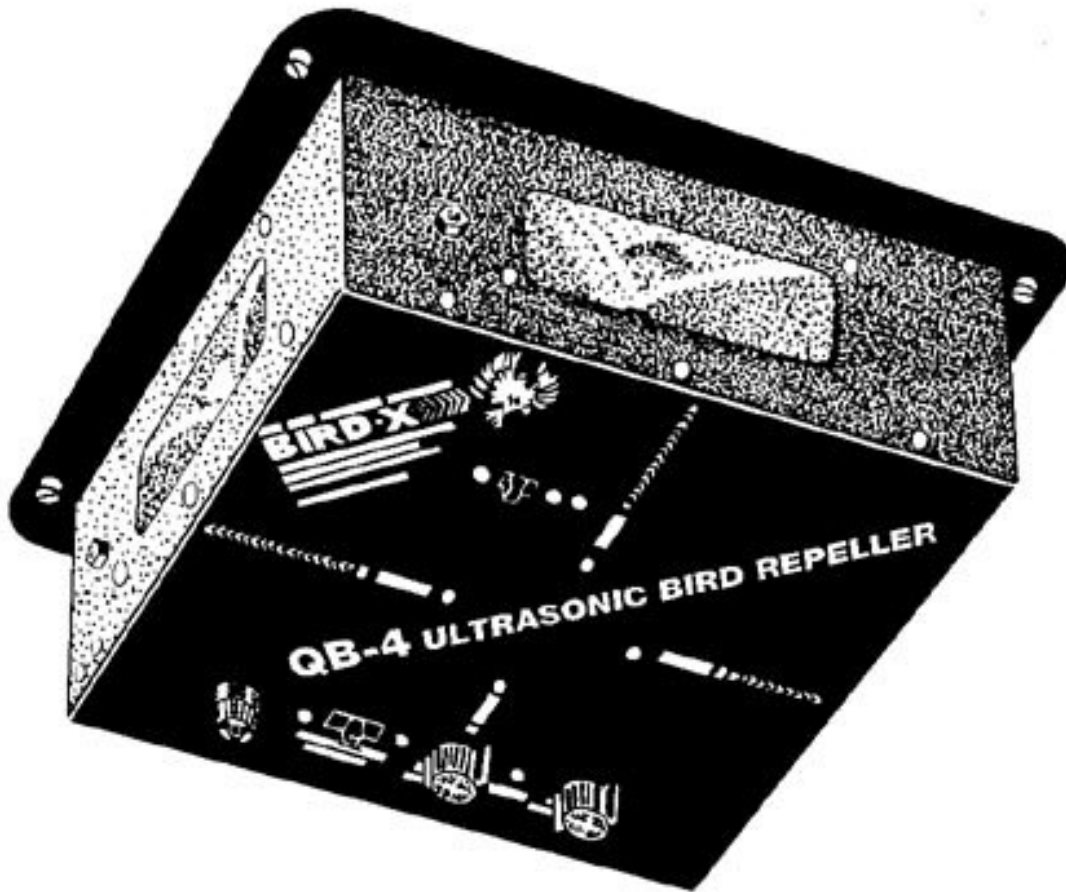

Designed and manufactured by:



300 N. Elizabeth St.
Chicago, IL 60607
USA

Phone 312-226-2473
FAX 312-226-2480

E-mail sales@bird-x.com www.bird-x.com

TABLE OF CONTENTS

I.	Introduction.....	3
II.	Why Control Birds?.....	3
III.	Bird Management Program.....	4
IV.	QB-4 Ultrasonic Bird Repeller.....	5
	A. Brief Description of Unit and How It Works	
	B. Specifications	
	C. Controls	
V.	Sound Distribution Pattern.....	7
VI.	Mounting Instructions.....	8
VII.	Applications.....	8
VIII.	Use of Variable Features.....	9
IX.	Trouble Shooting.....	10
X.	Precautions.....	11
	A. Hearing Protection	
	B. Electrical	
XI.	Warranty and Guarantee.....	11
XII.	Synergy and Other Products.....	11

*** see back cover "Addendum for Use Against Rodents"**

I. INTRODUCTION

Bird-X, Inc., the world's leading bird control specialists and suppliers of unique, effective and ecologically safe bird repelling products, is proud to announce "The Next Generation" in bird control. We have successfully utilized the latest in Space Age Technology and electronics to develop the all new **QB-4 Ultrasonic Bird Repeller**.

Bird-X, Inc. has been recognized worldwide as the bird control experts for more than 30 years. **Bird-X, Inc.** is the only company anywhere that sells a complete line of bird repelling products (currently 15), including a variety of ultrasonic and sonic machines, visual repelling devices, non-toxic chemical roosting inhibitors, iridescent diffraction foil, netting and metal spike strips. New products are continuously being developed.

Bird-X, Inc. specialists have become experts through extensive experience and research. As a result, sales consultants are able to analyze problems and make recommendations based on each customer's specific situation and needs. In addition, **Bird-X, Inc.** maintains and avails to customers a library of application case histories and other reference materials.

II. WHY CONTROL BIRDS?

- A. Bird droppings are unsightly and cause dangerous, slippery working conditions.
- B. Bird droppings are unhealthy - even potentially fatal. At least sixty transmissible diseases have been associated with birds and their excrement.
- C. Bird droppings cost money. Time and materials for "cleaning up" represent costs unrecoverable by revenues.
- D. Birds are destructive. They deface floors, walls and equipment. They halt operations and make repairs necessary by entangling themselves in machinery or downing power lines. They spoil inventory by eating spillage, contaminating pallets of food, drugs or chemicals, or by bombarding aircraft and other durable goods with uric acidic excrement. They nibble at, or even tear out insulation.
- E. USDA, OSHA, local health boards and other governmental organizations can cite companies for bird mess problems. If the problems are not corrected, companies can be fined or shut down.

III. BIRD MANAGEMENT PROGRAM

No two bird infestation problems are exactly the same. Treat yours as you would any well engineered project, and begin with research. Success depends on timing, organization and diversity.

Collect information related to the bird problem:

- A. **Survey the birds and their habits.** Gather specific data as to the type and population of birds, flight and time patterns, entries and exits, and nesting, feeding and roosting habits.
- B. **Inspect your property.** Discover what the birds find attractive about your area, and if the same conditions prevail in neighboring properties.
- C. **Remove all inducements.** Before installing the **QB-4**, make sure to clean the area of all evidence of birds: nests, fledglings, droppings, dead birds, and the residual scent. (Adult birds are likely to return to their young in order to protect them or to assist them in leaving the area.) Remove food spillage, garbage, nesting material and other items that may be appealing to birds.
- D. **Maintain a clean and changing environment.** For maximum effectiveness, periodically clean the area of nests and droppings, relocate or reposition the **QB-4**, vary the output, or turn off the unit for a short time.
- E. **Install early.** It is always best to install the **QB-4** before "bird season" begins, as it is easier to keep the birds away than to rout them out once they have already established a living pattern.
- F. **Use products synergistically.** Two or more different kinds of devices (the **QB-4** plus a visual scare product and/or a roost inhibiting device) will produce a synergistic effect -- i.e., in combination, the products will yield much greater effectiveness than the **QB-4** alone. Contact **Bird-X, Inc. at (312) 226-2473 (BAN BIRD)** for information on "companion" products.
- G. **Consider alternate locations.** Make educated guesses as to where the birds will go when they are repelled from their current infestation area. It may be very easy for birds to relocate to the other side of a warehouse, or to an adjacent loading dock. Units should be purchased to cover these alternate areas as well.
- H. **Note the legal and public relations environment.** Find out about related environmental laws in your area.

IV. QB-4 ULTRASONIC BIRD REPELLER

A. BRIEF DESCRIPTION OF UNIT AND HOW IT WORKS

The **QB-4** is a sophisticated ultrasonic sound generator that is equipped with several features to enhance its effectiveness and its ability to provide both immediate and long term bird control.

The **QB-4** is an electronic oscillator tuned to oscillate between 22 and 30 kHz. It is powered by alternating current between 110 and 120 volts. (A special export model, QB-4/220, is available for use with voltages between 220 and 250 volts.) It produces an intense ultrasonic sound measured at approximately 112 dB at 1 meter at 22 kHz.

The **QB-4** is designed to do a twofold job:

1. Rout birds from firmly established *Spatial Infestations* by assailing them with an intolerable sound (see Diagram IV-a); and once out,
2. Keep birds out by forming a *Perimeter Defense* through which the birds will not want to re-enter the premises (see Diagram IV-b).

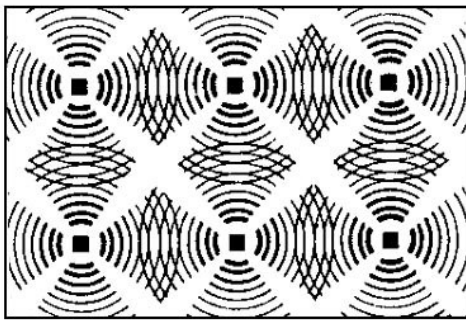

Diagram IV-a: Spatial Infestations - illustrates a solution for a widespread bird problem. The atmosphere is totally saturated by the use of multiple units. The sound waves overlap and cover the whole area.

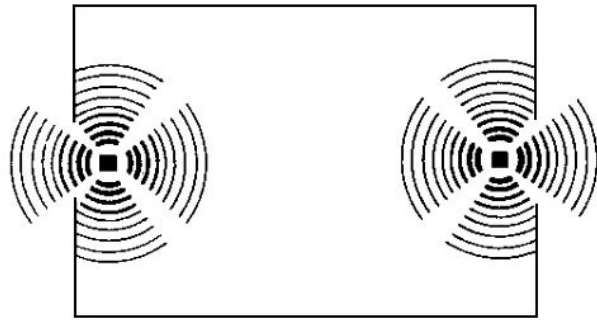

Diagram IV-b: Perimeter Defense - demonstrates the placement of the units once the bird problem is under control. The *Perimeter Defense* discourages birds from returning.

NOTE: The QB-4 was designed to be used only in an *enclosed area* or a *semi-enclosed area*. Because outdoor areas do not have the benefit of confining surfaces, ultrasonic sound waves dissipate rapidly and lose most of their effectiveness.

B. SPECIFICATIONS

Power Requirement: 115 vAC/60 hz or
 230 vAC/50 hz
 Power Consumption: 3 Watts (Steady Mode)
 Fuse: 1 Amp Fast Blow, .250 x 1.250", Agc 1
 Sound Pressure Level: 112 dB @ 1 meter @ 22 kHz
 (each speaker)

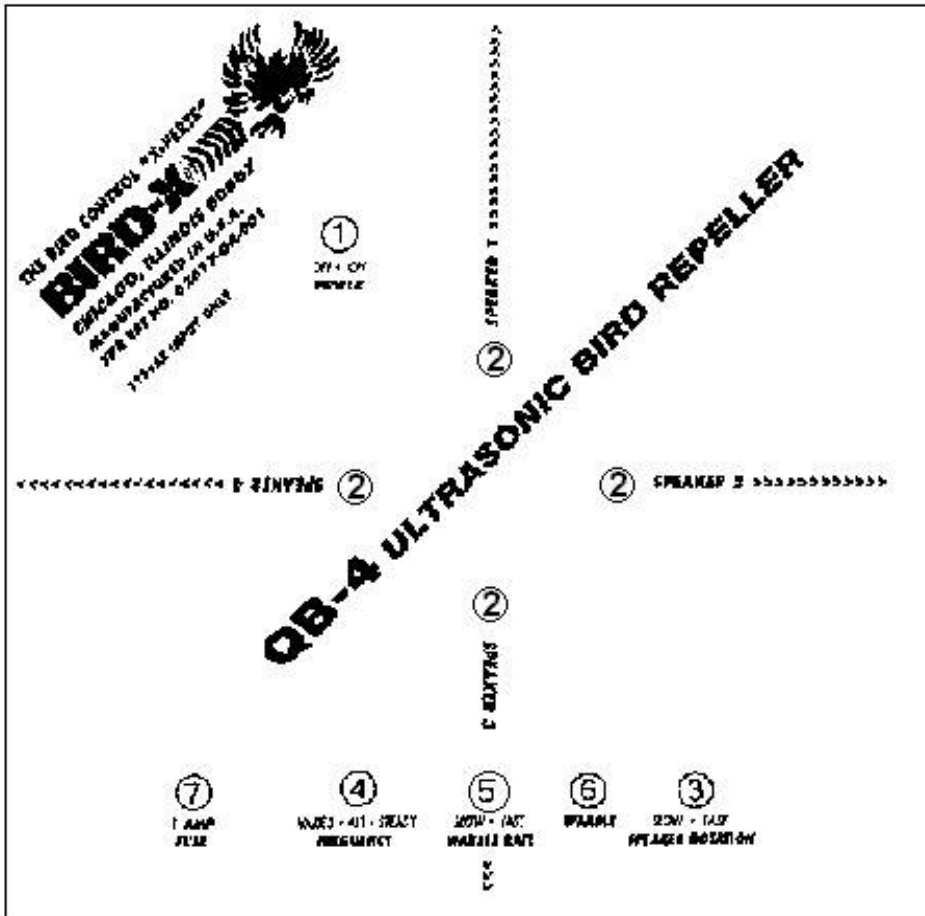

Diagram IV-c: QB-4 Control Panel

C. CONTROLS (see Diagram IV-c)

1. Power Switch: Turns unit ON and OFF
2. Speaker Lights: Indicate rotation rate.
3. Speaker Rotation Knob: Adjusts rotation rate from slow to fast (10 to 110 rpm).

4. Frequency Switch: Has three positions -- Varied, Alternate and Steady.
Varied - Modulates frequency up and down at a rate controlled by the warble rate knob. During each cycle, the frequency modulates between 22 kHz and 30 kHz with peak sound pressure levels occurring at 22 kHz.
Alternate - Alternates output between varied mode and steady mode, each mode lasting for 12 seconds.
Steady - Fixes sound output at a constant 22 kHz.
5. Warble Rate Knob: Adjusts warble rate from slow (40 cycles per minute) to fast (85 cycles per minute). Inoperative when the mode switch is set to "steady."
6. Warble Light: Flashes on and off to indicate warble rate when in varied mode and stays on to indicate steady mode.
7. 1 Amp Fuse: Contains a 1 Amp post-type fuse.

V. SOUND DISTRIBUTION PATTERN

The **QB-4** provides coverage throughout a circular area with an approximate radius of 45 feet (see Diagram V-a). Each **QB-4** is capable of covering from 3,000 to 6,500 square feet, depending on the nature of the building's construction and contents (see Diagram V-c for square foot coverage per sound dispersing unit). Total spatial coverage is dependent on environmental surroundings: type of building construction; storage contents; physical layout, etc. Total spatial coverage should exceed 6,500 square feet prime coverage plus an additional secondary coverage dependent on the surroundings. Each of the four speakers creates a dispersion pattern of 2:1 (wide to high, see Diagram V-b).

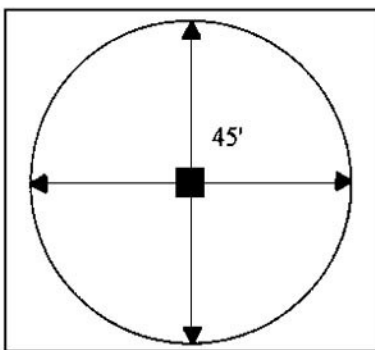

Diagram V-a: Effective Range

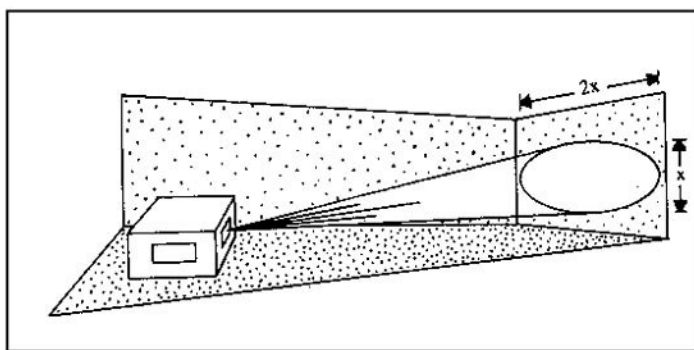

Diagram V-b: Dispersion Pattern

NOTE: When using multiple **QB-4** units, they should be placed no more than 90 feet apart (based on a 45-foot radius).

BASIC CONSTRUCTION

PRINCIPAL CONTENTS	<u>Steel</u> or other metal	<u>Concrete</u> or Masonry	<u>Wood</u>	
	<u>Metal</u> or other hard objects	6,500	5,250	4,500
	<u>Wood</u> or other semi-hard objects	5,500	4,750	4,000
	<u>Cloth</u> grain or other absorptive objects	4,500	3,750	3,000

(Figures are in square feet.)

Diagram V-c: Basic Construction Chart

VI. MOUNTING INSTRUCTIONS

There is no top or bottom to the unit, so it can be mounted in any direction -- on any plane -- with screws, nails, wires or adhesives.

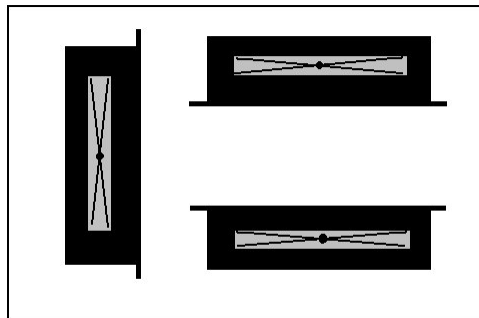

Diagram VI-a: Mounting Alternatives

VII. APPLICATIONS

The **QB-4** is designed to act as an important aid in routing birds from their infestations in plants, warehouses and semi-enclosed locations such as loading docks, railroad sidings, tunnels, breeze-ways, underpasses and storage sheds. Other locations include: hangars, silos, barns, stadiums, arenas, boat houses and bell towers. See Diagrams VII-a, VII-b and VII-c (on page 9) for examples of typical installations.

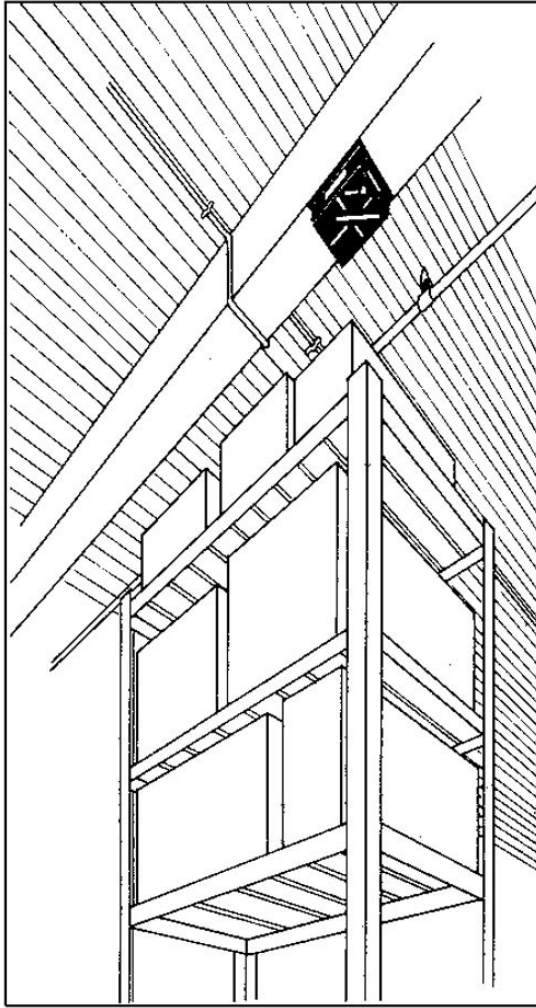

Diagram VII-a: Warehouse Interior

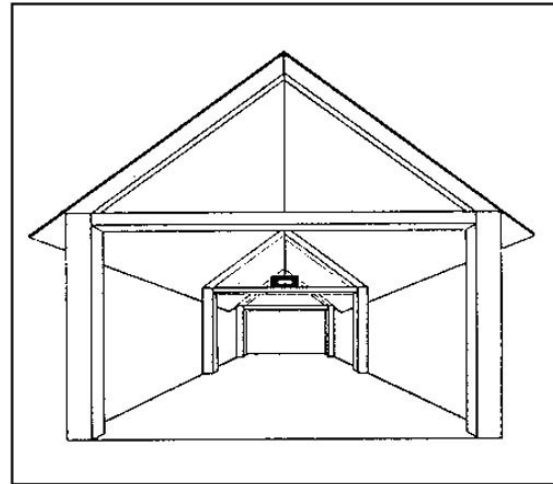
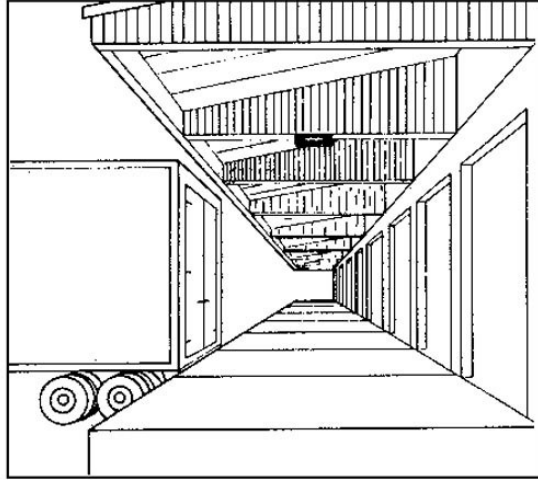

Diagram VII-b (above): Loading Dock
Diagram VII-c (below): Gabled Roof/Ceiling

VIII. USE OF VARIABLE FEATURES

Every bird infestation presents a unique challenge. No two problems are identical, as numerous variables affect each one. Besides the obvious differences (such as type of bird, size of infestation, type of structure and physical location), there are many additional environmental factors that make it impossible to state rigid rules for the optimum utilization of the variable features of the **QB-4**. The following are suggestions to help maximize the effectiveness of the unit, but experimentation is often required to find the ultimate solution.

The use of the variables: **Frequency Mode Selection**, **Speaker Rotation Speed**, and **Warble Rate** create changing environments to repel roosting birds. Change is one of the best tools in the repelling of birds, as birds are creatures of habit and they do not grow accustomed to a dynamic environment.

For general, spatial coverage (where the infestation is fairly evenly spread out, neither concentrated nor isolated) a cacophony of sound should be created, using as much variation as possible:

Example: Set -- **1. FREQUENCY** at *Varied or Alternating*;
2. WARBLE RATE at *Medium*; and
3. SPEAKER ROTATION at *Slow*.

A fourth variable is also available when two or more units are deployed. Simply stated, a variation in the dispersed sound is achieved when the units are mounted and directed somewhat offset from each other (rather than aligned, rank-and-file style). Think of each unit as being mounted on a universal joint; then merely "point" each in a slightly different direction. You will have created a fuller (i.e., not collinear) coverage.

For concentrated or isolated infestations the direction of the attack should be pinpointed. Use as much power and "monotony" as possible:

Example: Set -- **1. FREQUENCY** at *Steady* (which delivers a constant 22 kHz tone and eliminates "warble" altogether); and
2. SPEAKER ROTATION at *Fast*.

If multiple units are used, they should be aligned and concentrated along the same axis if and when possible.

For all infestations that lie between the two extremes described above, the best suggestion is to interpolate, using all three (3) variable options on the Control Panel.

IX. TROUBLE SHOOTING

- A. Check that the power switch of the unit is on. When the unit is on and functioning the speaker light will flash on when the respective speaker is on.
- B. Housekeeping is very important! As mentioned in the Bird Management Program, the problem area should be cleaned of all evidence of birds. Nest, fledglings, droppings, dead birds, and the residual scent should all be removed. Check the area for unusual incentives. Remove food spillage, garbage, nesting materials and other items that may be appealing to birds.
- C. Check the settings on the unit. Change them on a *weekly* basis until a suitable range is found, and then change the settings, within that range, on a *monthly* basis.

X. PRECAUTIONS

A. HEARING PROTECTION

Even though 22-30 kHz is above human hearing range (which averages, at top level, about 16 kHz), the intensity of 112 dB is great enough to present a chance of damage to the ear if it is directly exposed for an extended period of time at a distance of less than 10 feet. These units should definitely not be located at or near a work station where employees will be located for an entire work shift. Normally, this type of unit is located high in the roof supporting structure at a considerable distance from personnel, and thus presents no problem when located in this manner. For the benefit of the person mounting and testing this unit a set of earplugs has been included. PLEASE USE THE ENCLOSED EARPLUGS.

B. ELECTRICAL

As with any electrical device, do not place the unit in or near water and do not mount it while standing in or surrounding by water. Although the unit is weather resistant, it is not recommended for use outdoors, or in any area where water can enter a speaker.

XI. WARRANTY AND GUARANTEE

Manufacturer's Warranty: The **QB-4** is warrantied against defects in materials and workmanship for a period of six months from the shipping date. At the option of **Bird-X, Inc.**, we will either replace or repair the defective unit.

Performance Guarantee: If the customer is not satisfied with the effectiveness of the **QB-4**, within 30 days from the shipping date, the unit may be returned, at the customer's expense, FOR CREDIT ONLY. Prior written authorization and a returned goods authorization (RGA) number will be necessary from **Bird-X, Inc.** All credits will be subject to a 15% restocking fee. NO RETURNS, OTHER THAN UNITS WITH DEFECTS IN MATERIALS AND WORKMANSHIP, WILL BE ACCEPTED AFTER 30 DAYS FROM PURCHASE. RETURNS ARE ACCEPTED ONLY WITH WRITTEN AUTHORIZATION FROM OUR CHICAGO OFFICE.

XII. SYNERGY AND OTHER PRODUCTS

For best results, **Bird-X, Inc.** always recommends that the **QB-4** be used in conjunction with one or more other products. The combination of different types of control methods has proven to maximize the effectiveness of bird control programs. Call **Bird-X, Inc. at (312) 226-2473 (BAN BIRD)** for more information on companion products.

Addendum for Use Against Rodents

The QB-4 is the next generation in ultrasonic pest control technology. In addition to repelling birds, the QB-4 will also repel bats, rats, mice and other rodents. *No adjustments to the unit are necessary.*

Mounting modifications: The unit should be mounted at the level of the infesting pest. For birds or bats, the ideal place would be in the rafters, up near the ceiling. For rodents, the ideal place would probably be the ground. However, rodents can climb very easily, and it may be necessary to mount units at somewhat higher levels as well, depending on the situation.

For rodent infestations, as for bird infestations, use products synergistically. Two or more different kinds of devices (the QB-4 plus bait bags or sticky glue traps) will produce a synergistic effect -- i.e., in combination, the products will yield much greater effectiveness than the QB-4 alone.

Copyright © 1994 by Bird-X, Inc. All rights reserved.